



**C-3PO™**

Item No. MMS270



It is highly recommended that you visit [www.metalearth.com/360/mms270](http://www.metalearth.com/360/mms270) to see the completed model before assembling your own

Insertion tabs are inserted and then folded

Insertion holes

Fold lines can be seen as shown here

**Legends:**

- E Engraved side
- NE Non-engraved side
- Attention point
- Insert tab and bend 90 degrees
- ▲ Insert tab and twist 90 degrees

**Recommended tools:**

- Wire cutters: helpful for taking parts from the metal sheets.
- Tweezers or needle nose pliers: helpful for folding parts, bending and twisting tabs.

**Assembly tip:**  
If needed, slightly twist tabs to hold parts together then untwist and bend them down for a nice finish

## Metal sheets

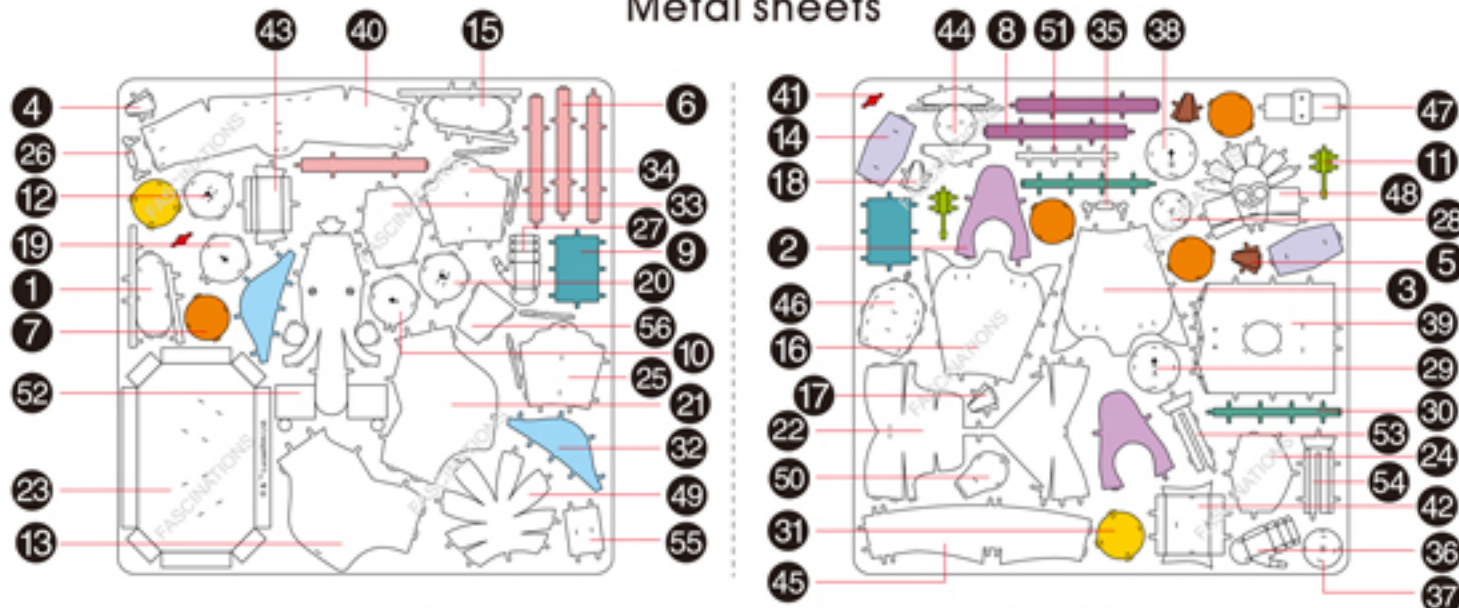

In order to avoid possible injury from sharp edges, please carefully discard the metal sheet after parts have been removed

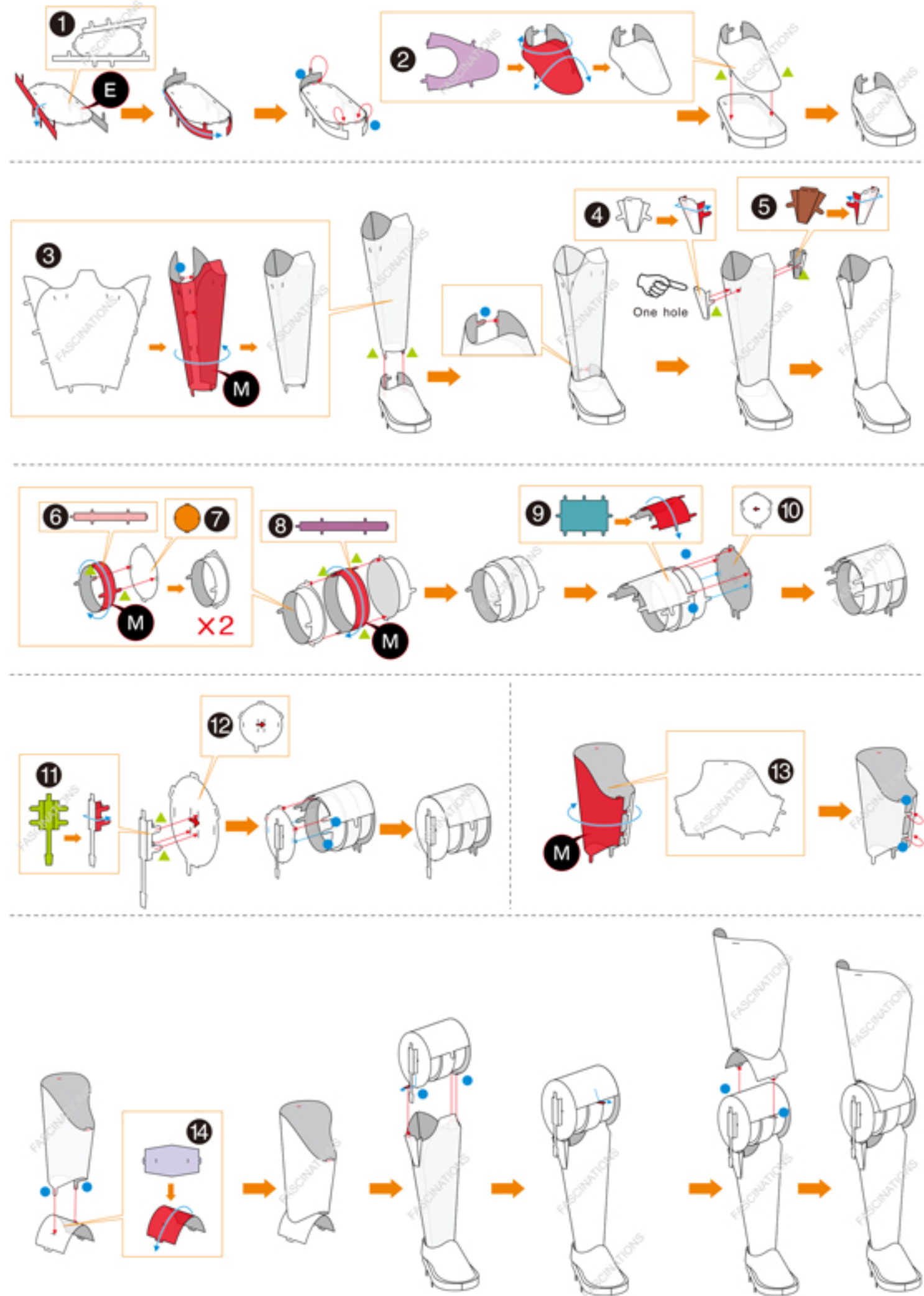

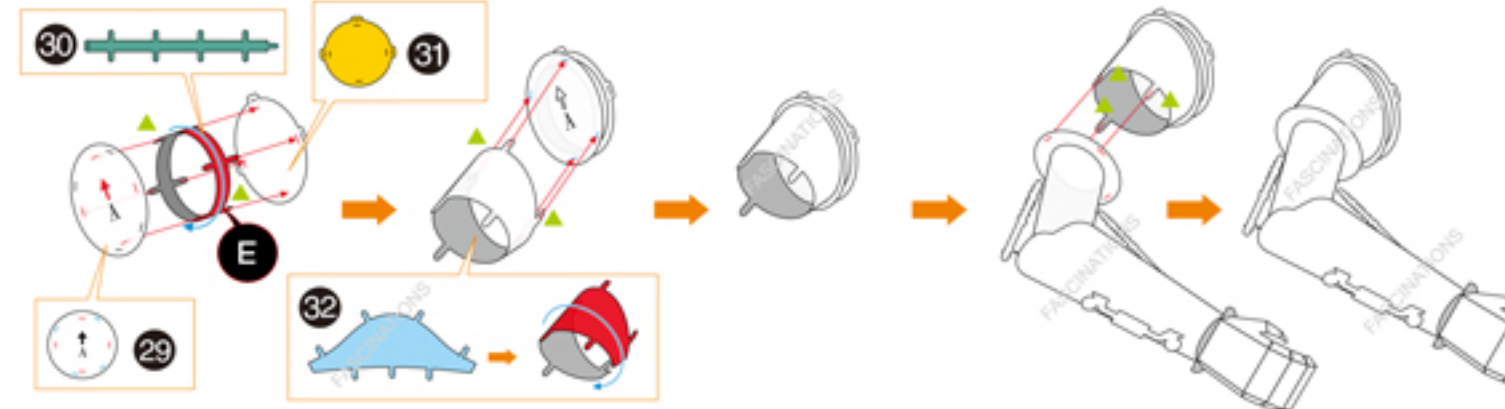
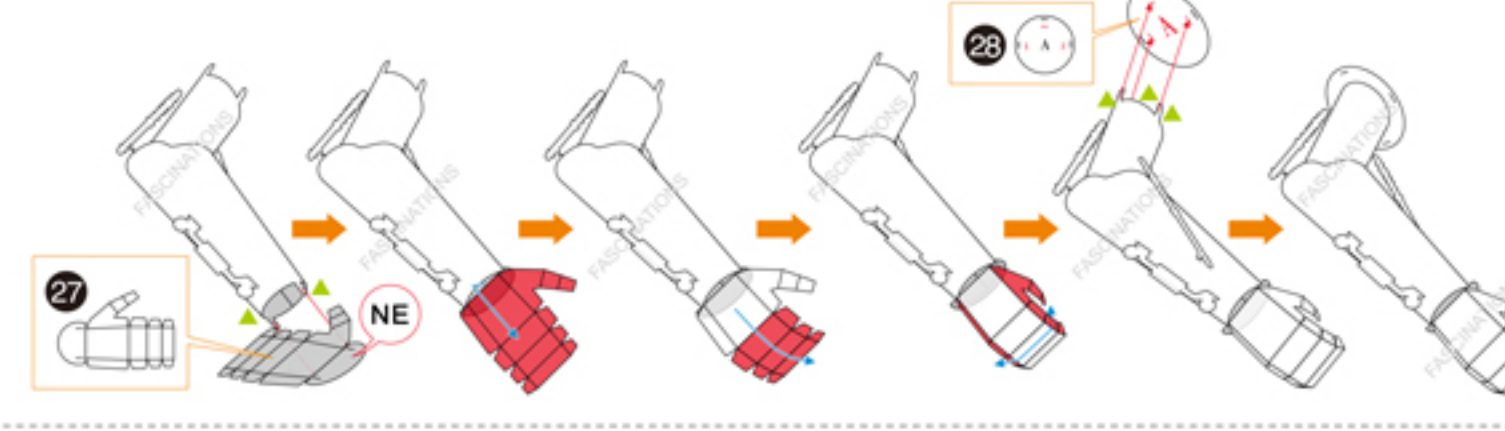
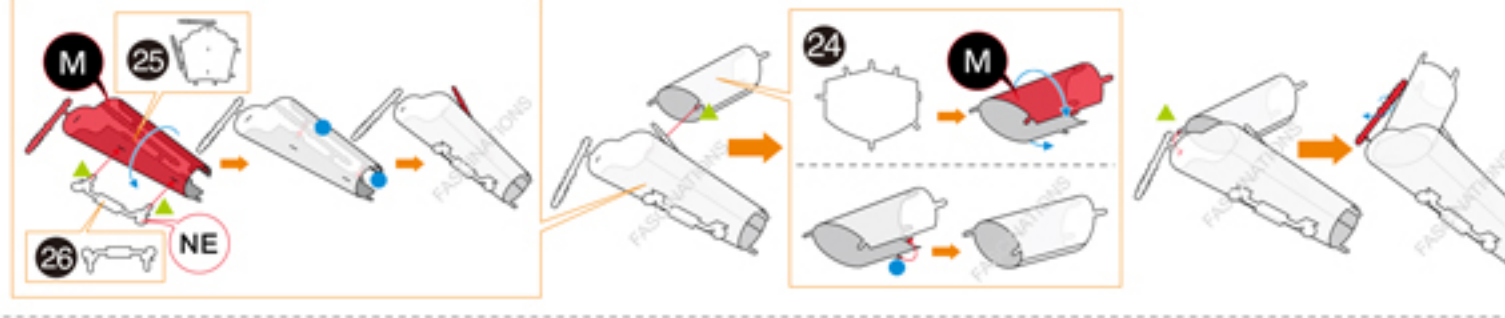
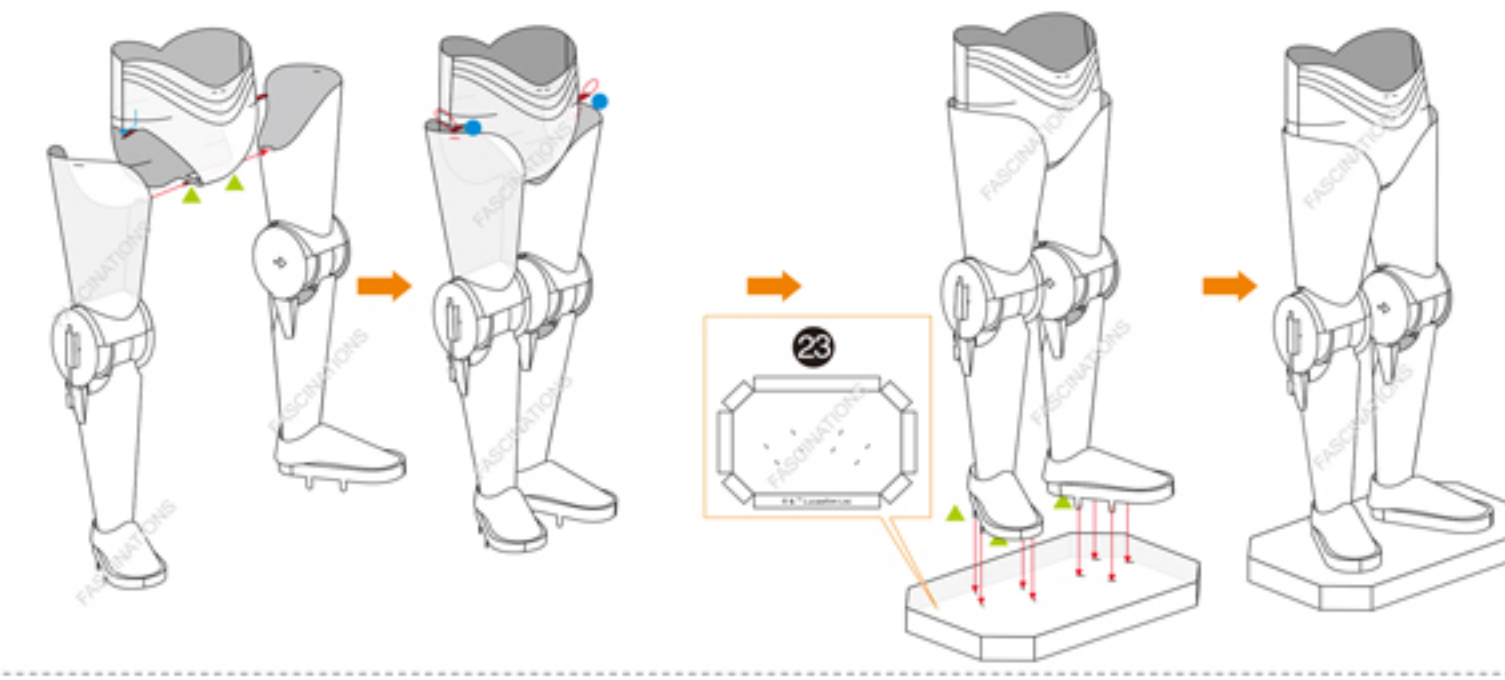
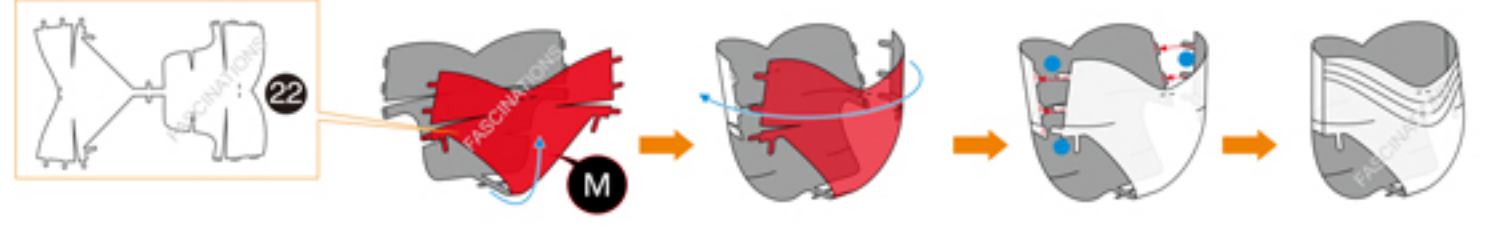
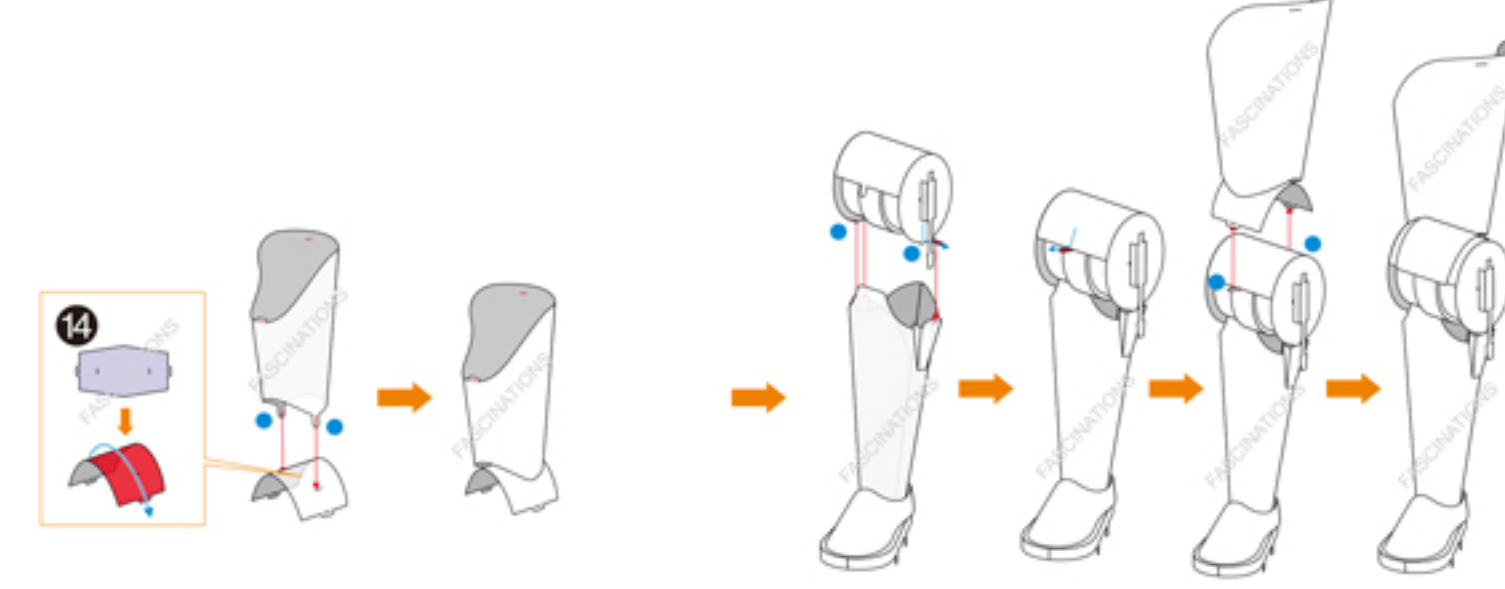
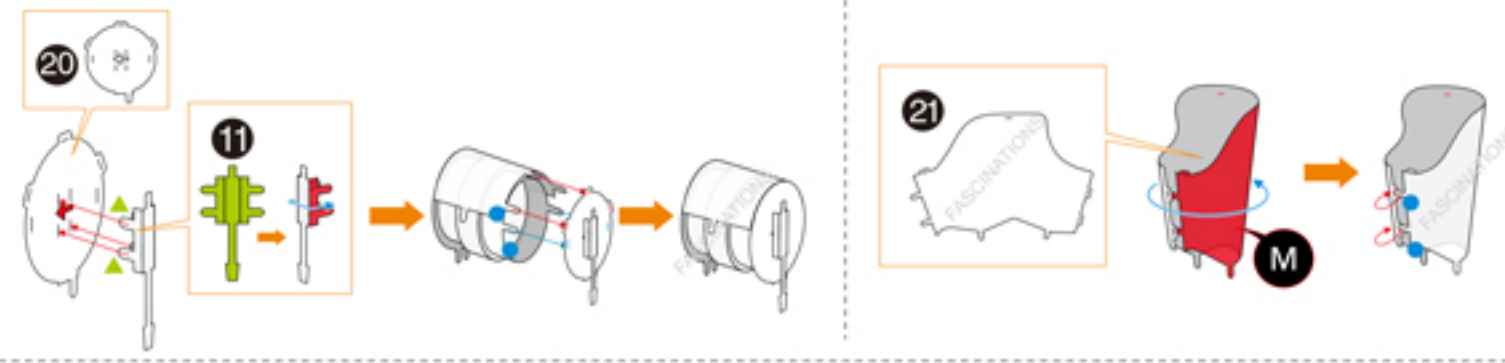
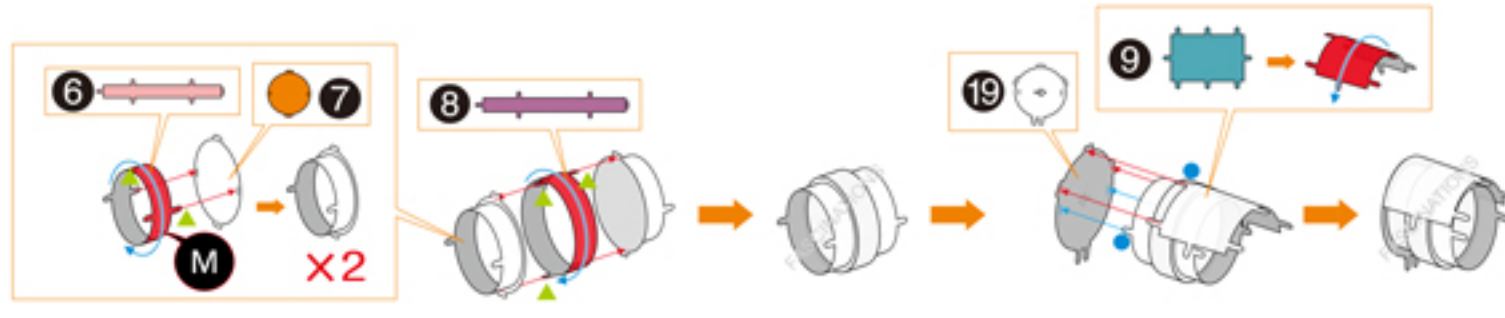
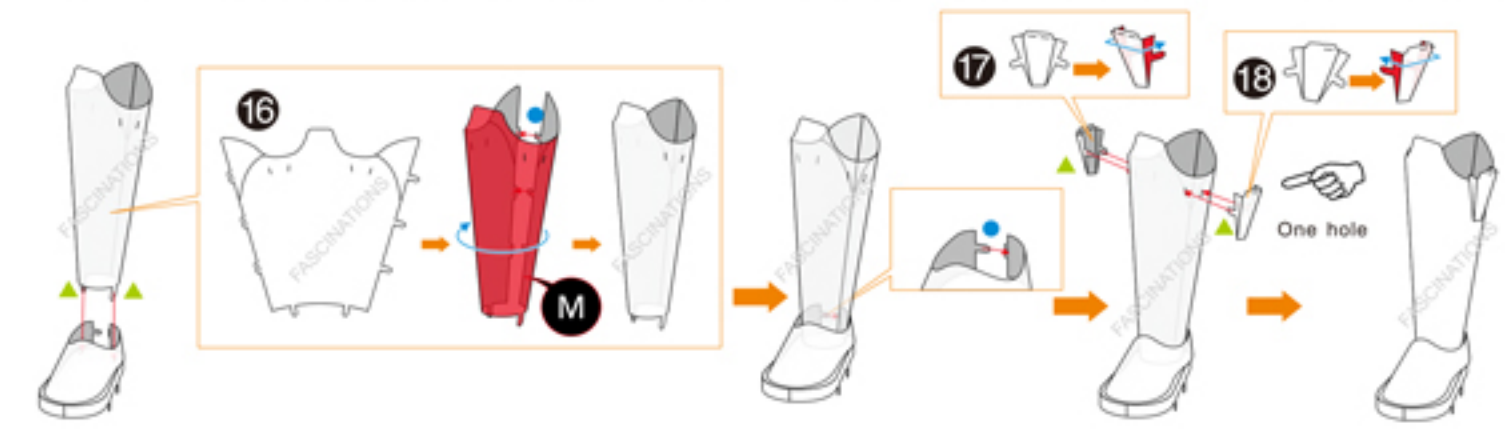
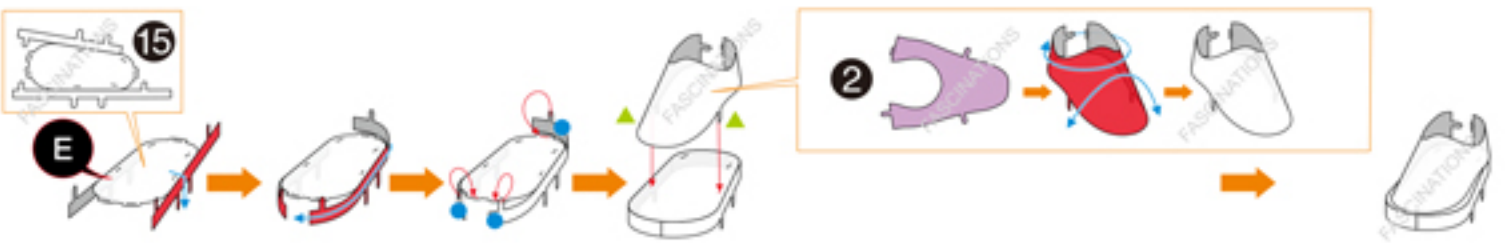

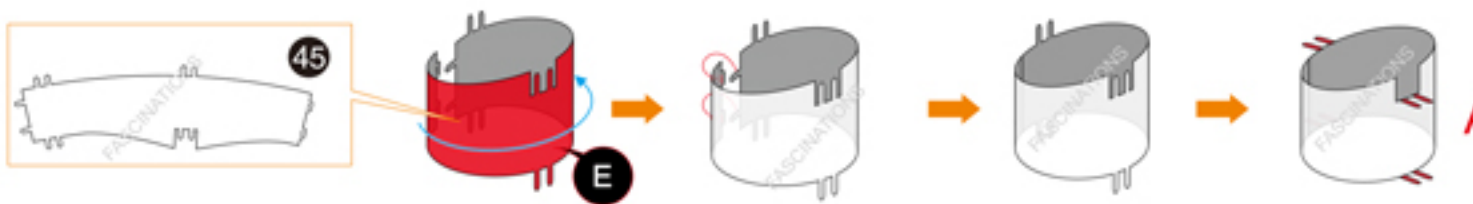
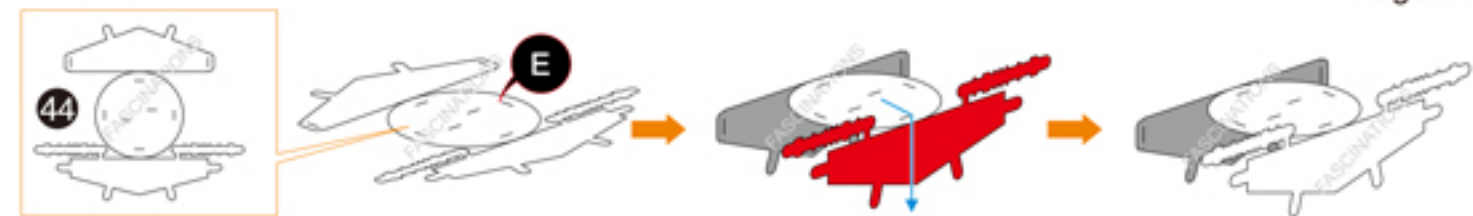
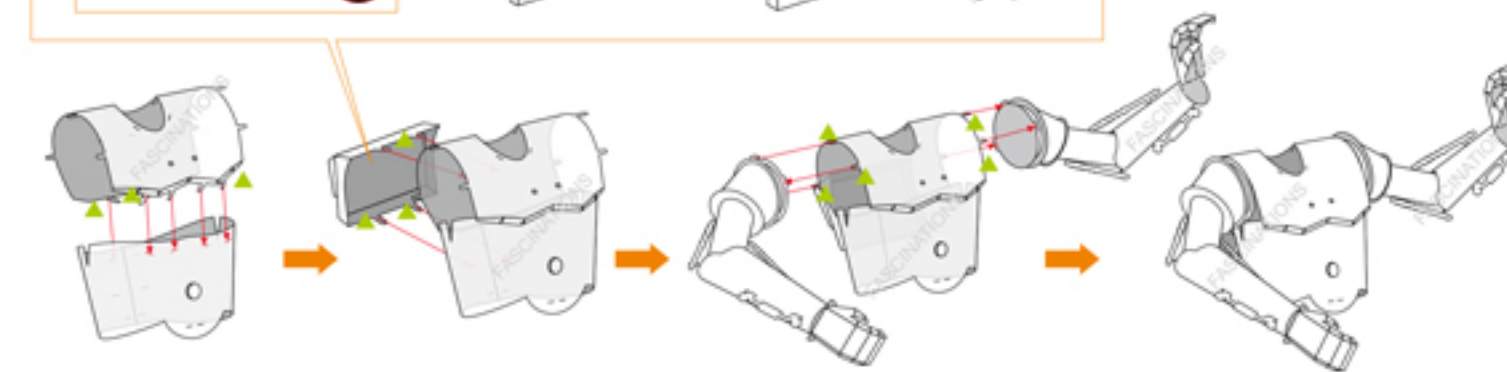
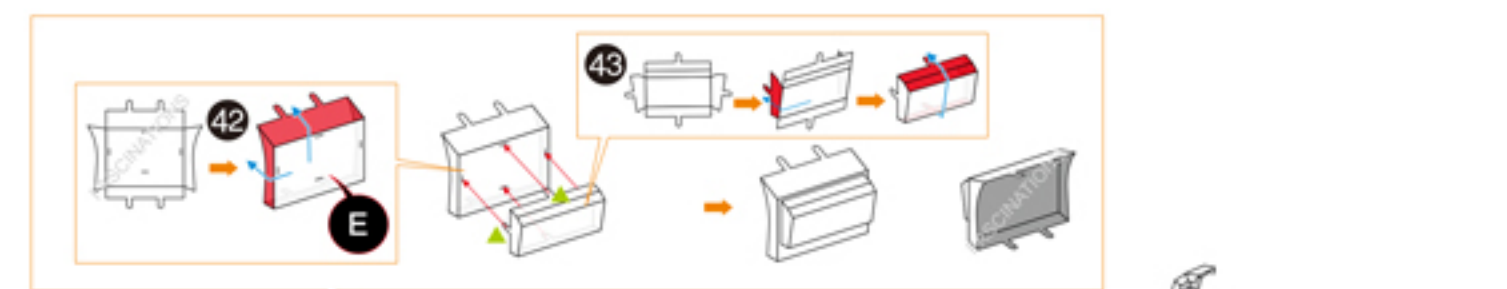
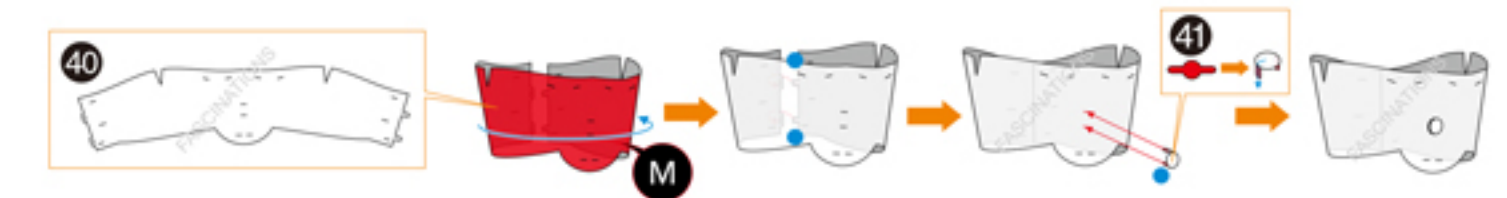
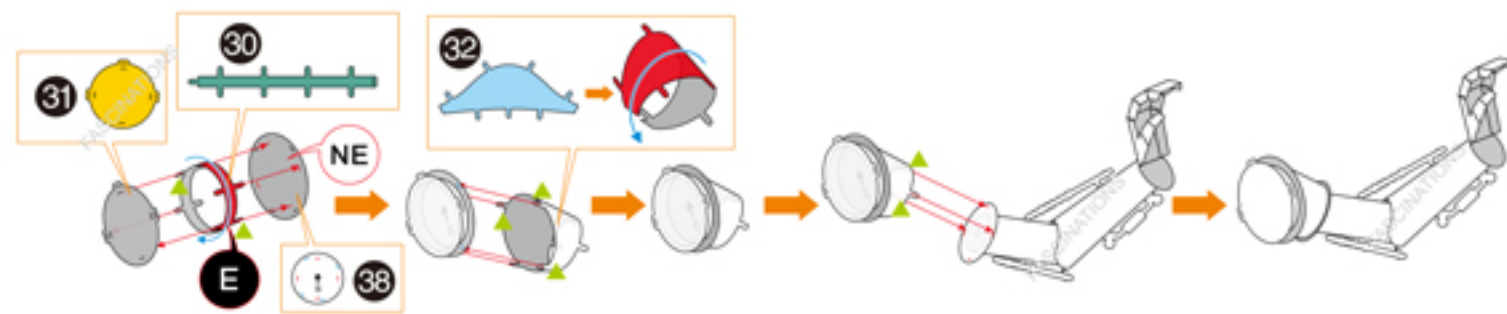
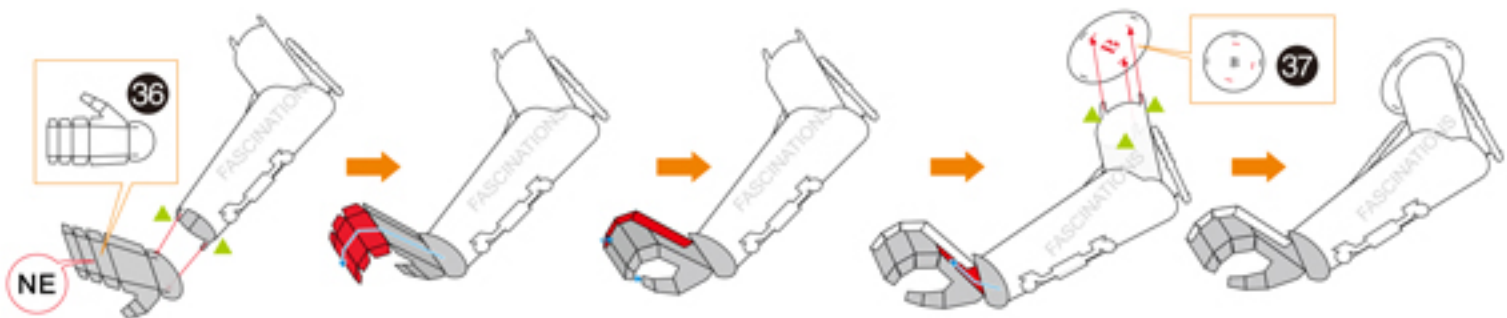
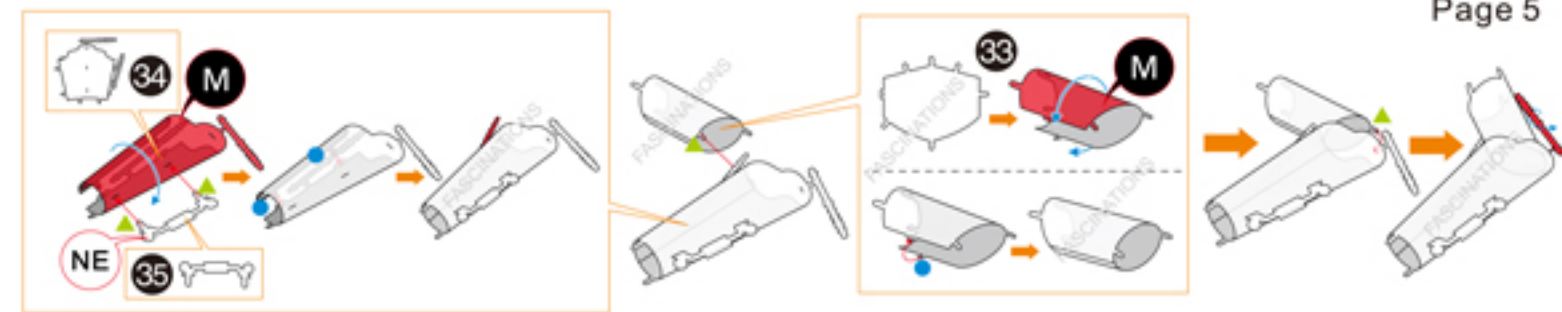

### Display Option 1

Tip: connect the 2 tabs at the top of the head first

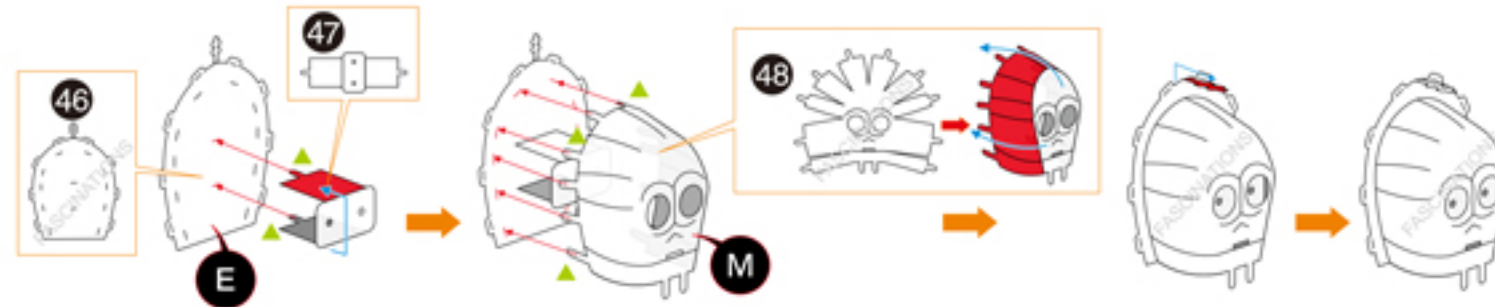

Tip: connect the 2 tabs at the top of the head first

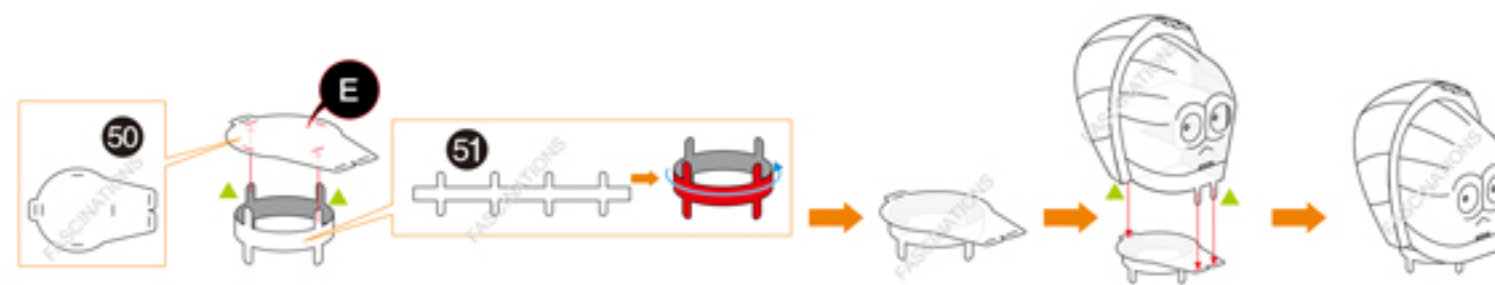

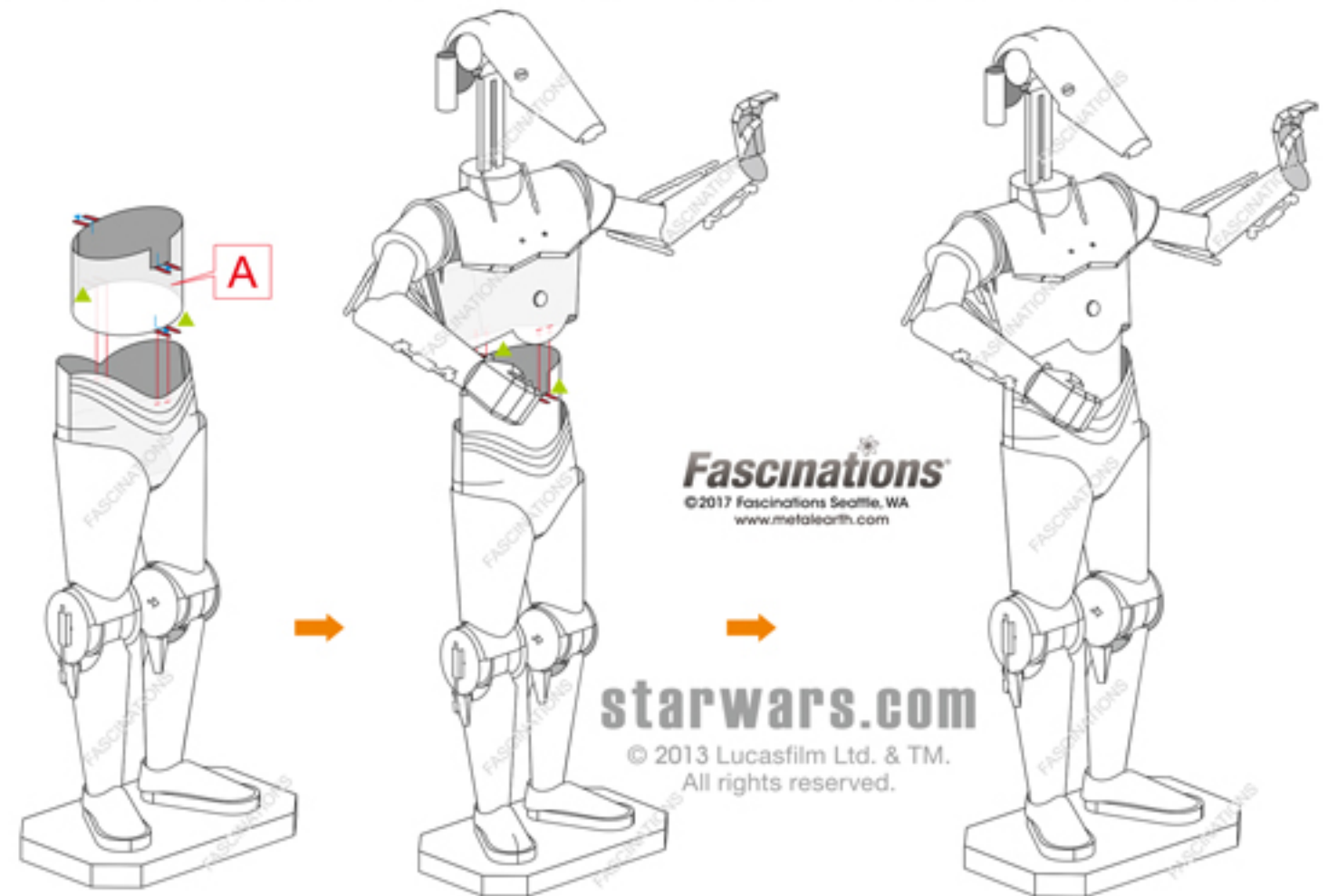
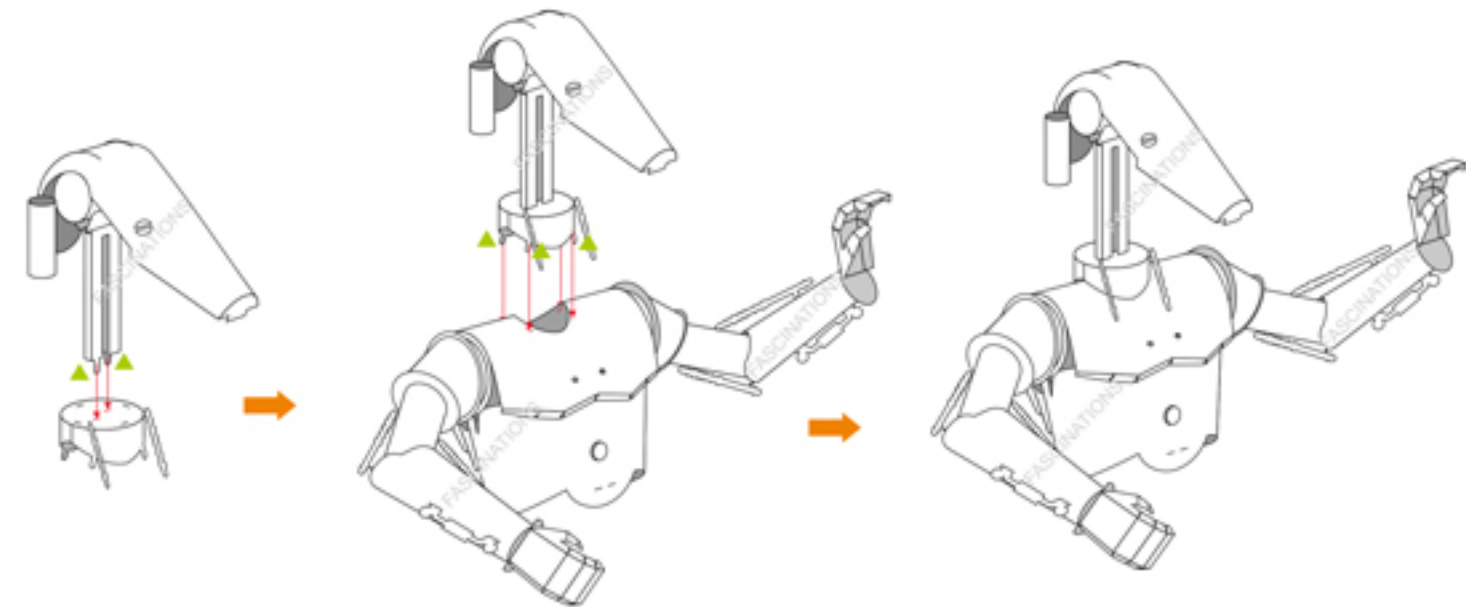
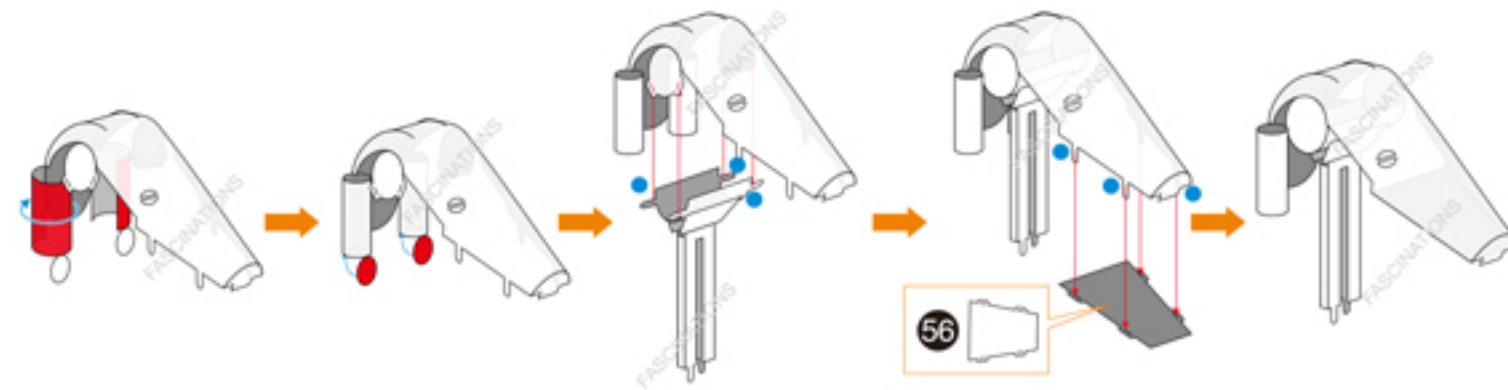
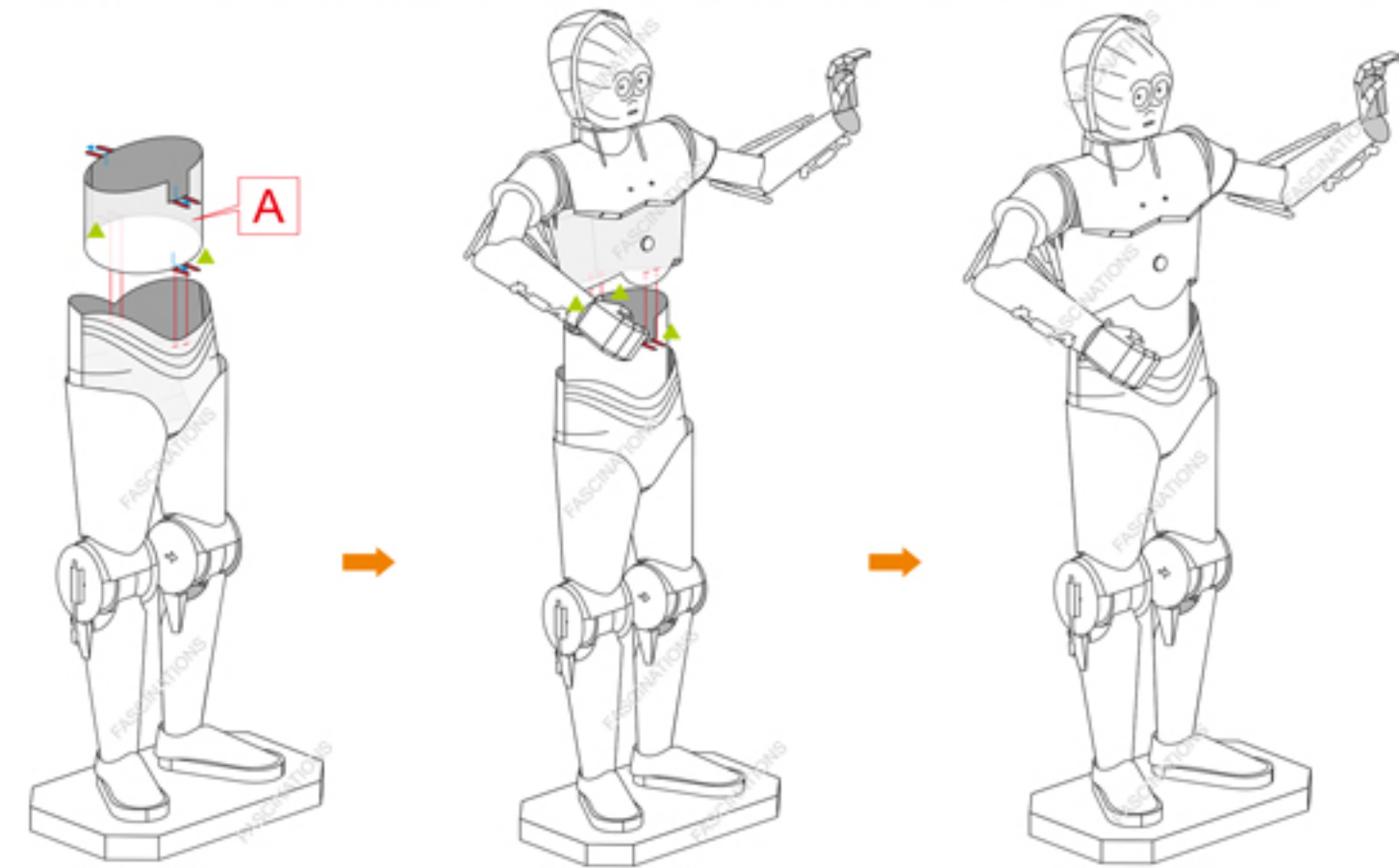
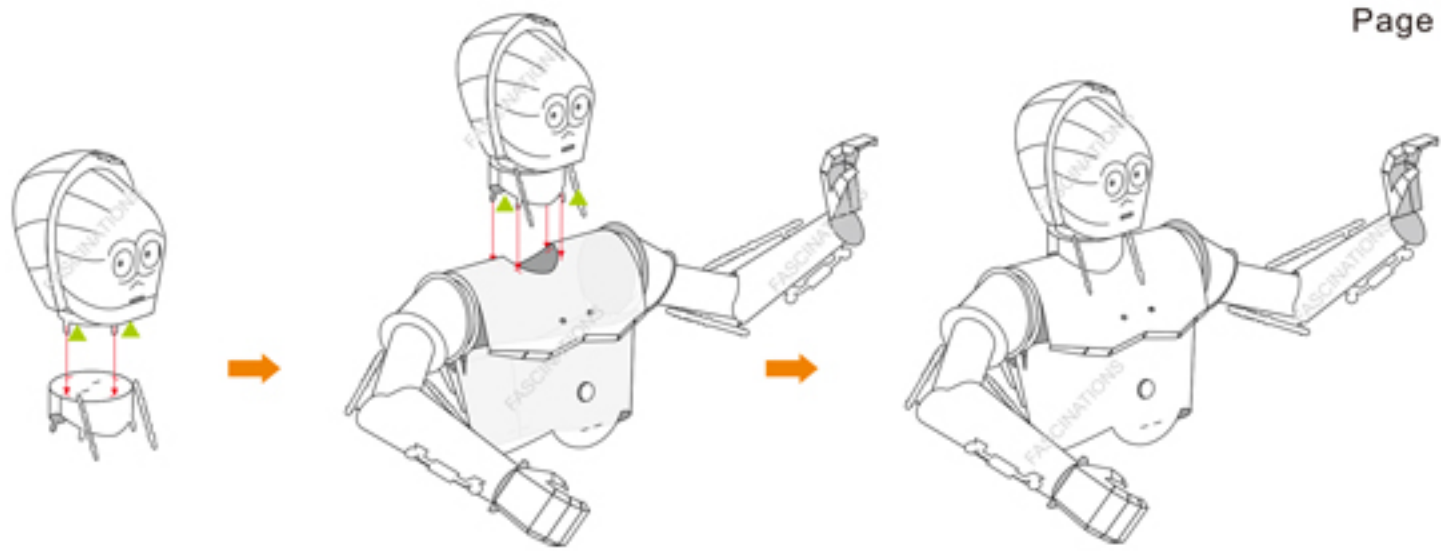

Display Option 2

