

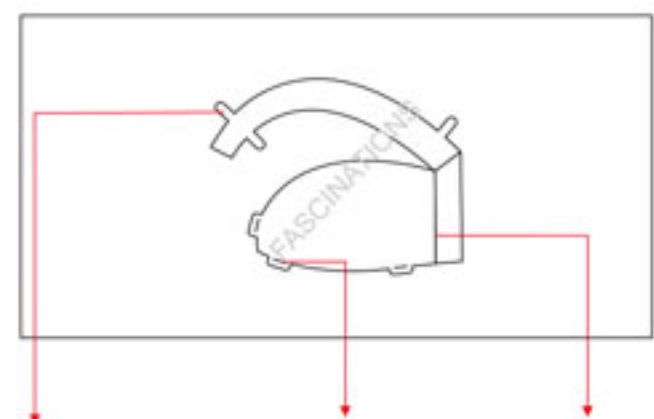

Darth Vader Helmet™
Item No. MMS314



It is highly recommended that you visit www.metalearth.com/360/mms314 to see the completed model before assembling your own



Insertion tabs are inserted and then folded
Insertion holes
Fold lines can be seen as shown here

Legends:

- E** Engraved side
- NE** Non-engraved side
- P** Painted side
- Attention point
- Insert tab and bend 90 degrees
- Insert tab and twist 90 degrees

Assembly tip:

If needed, slightly twist tabs to hold parts together then untwist and bend them down for a nice finish

Recommended tools:

-Wire cutters: helpful for taking parts from the metal sheets.



-Tweezers or needle nose pliers: helpful for folding parts, bending and twisting tabs.

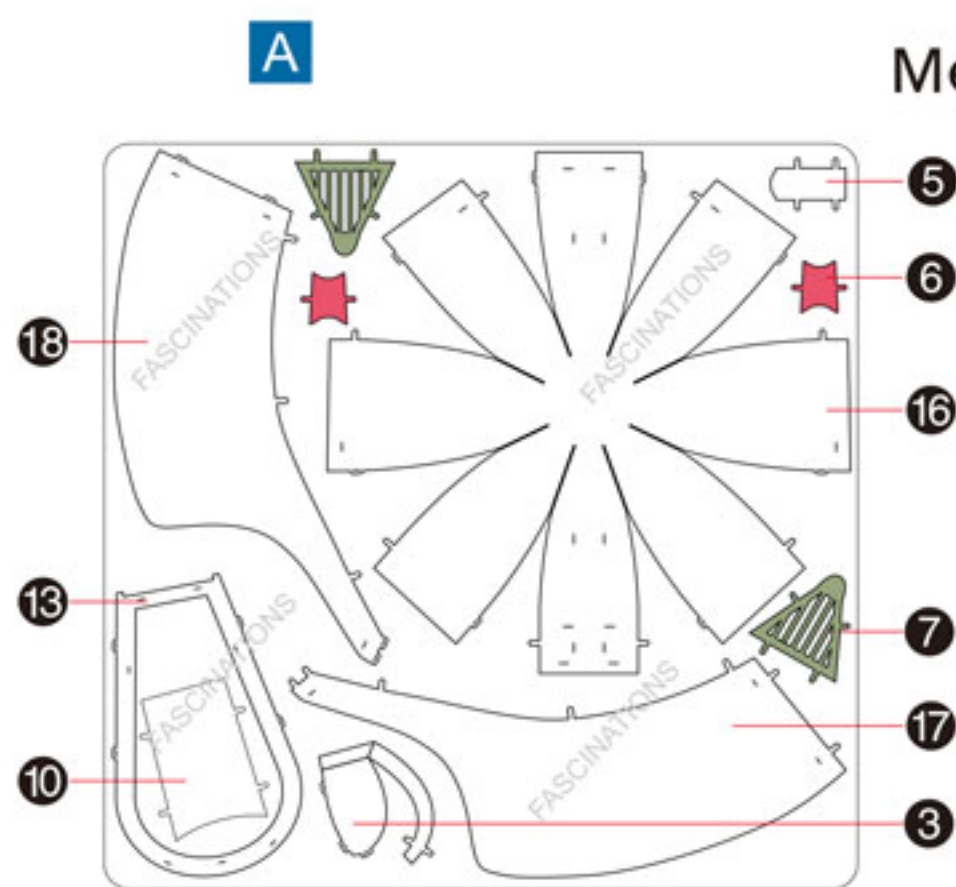
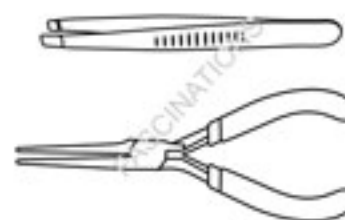

Metal sheets

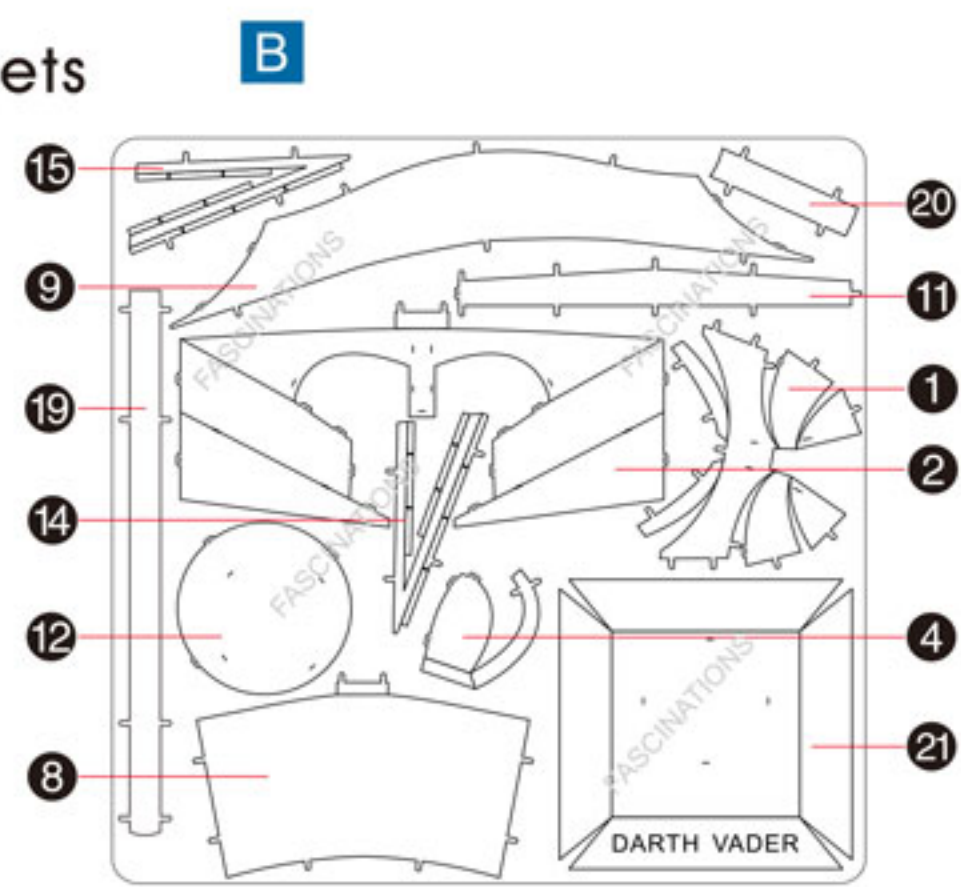

In order to avoid possible injury from sharp edges, please carefully discard the metal sheets after parts have been removed

Assembly Flow Chart

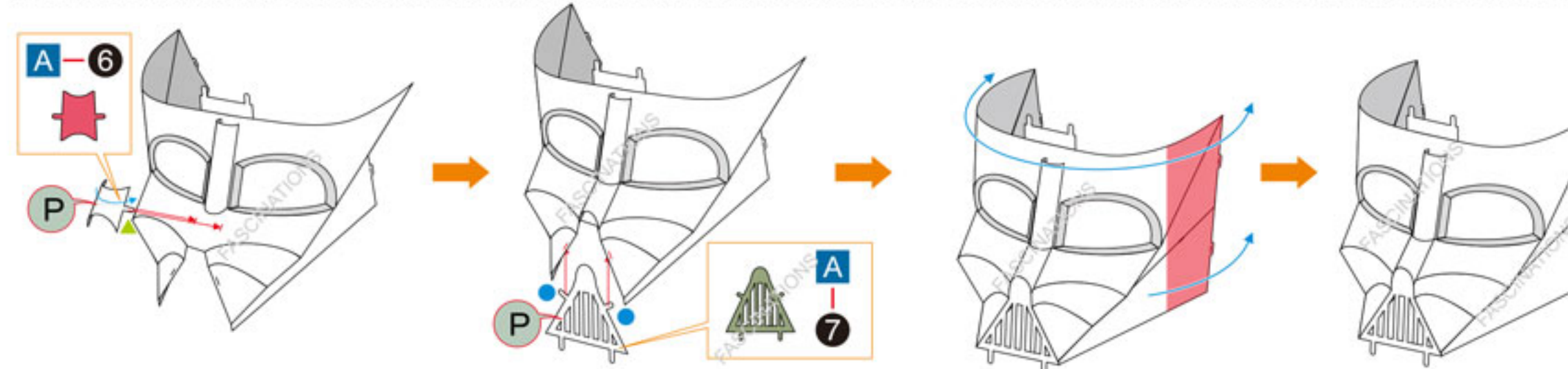
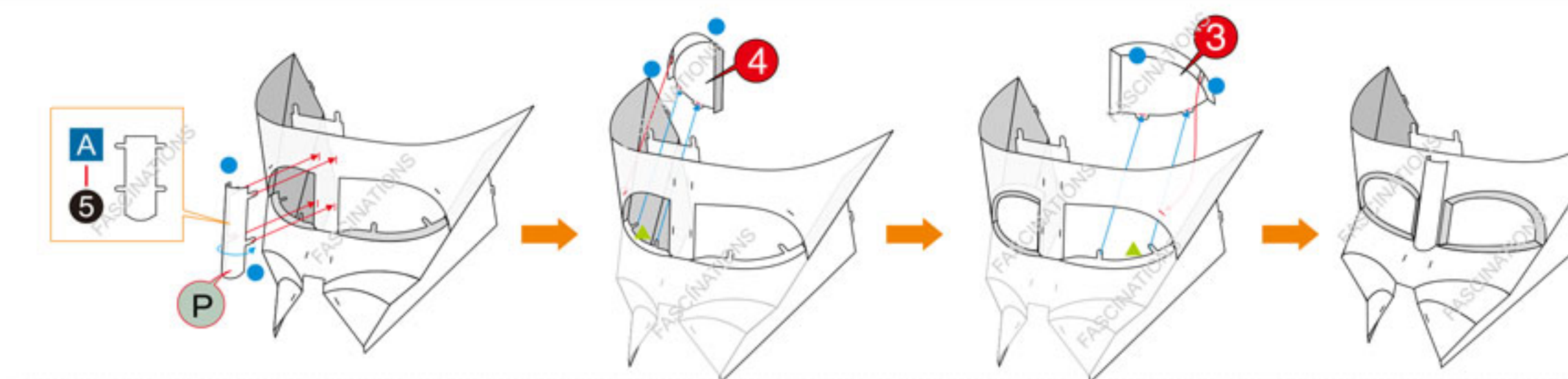
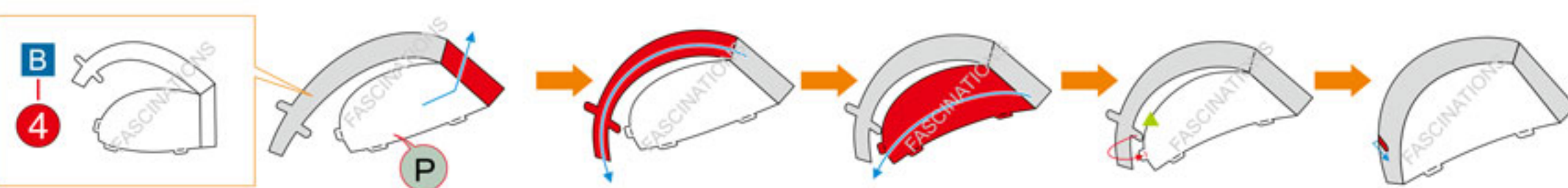
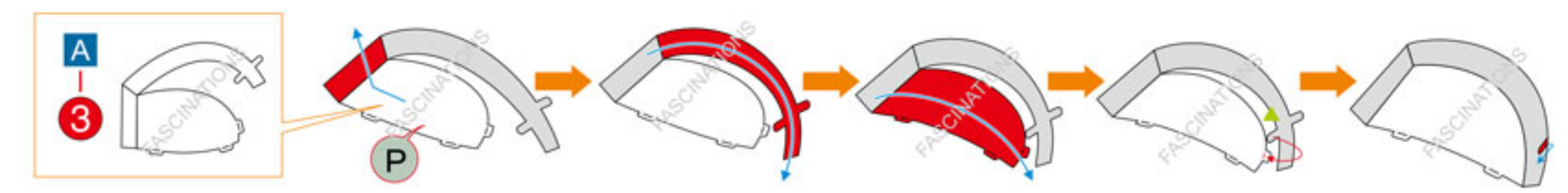
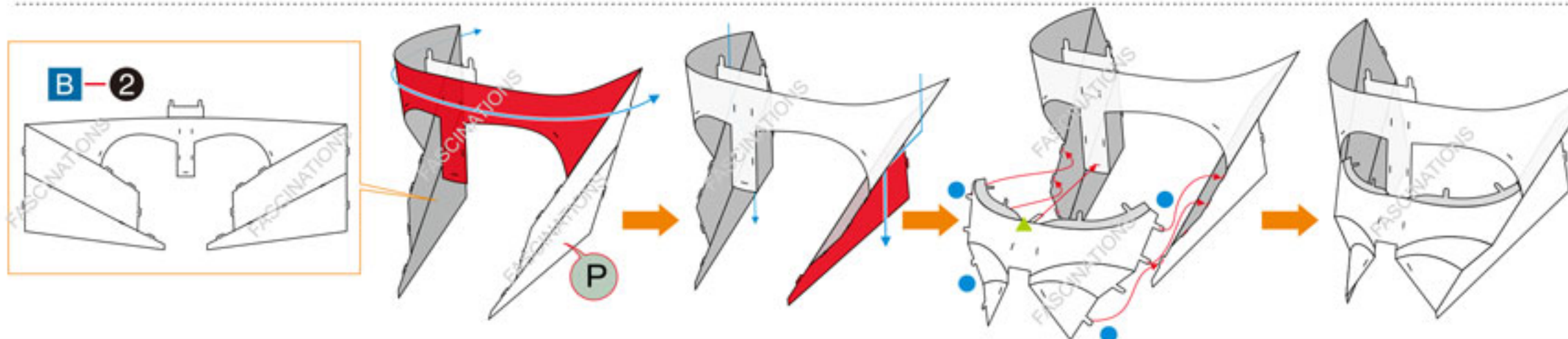
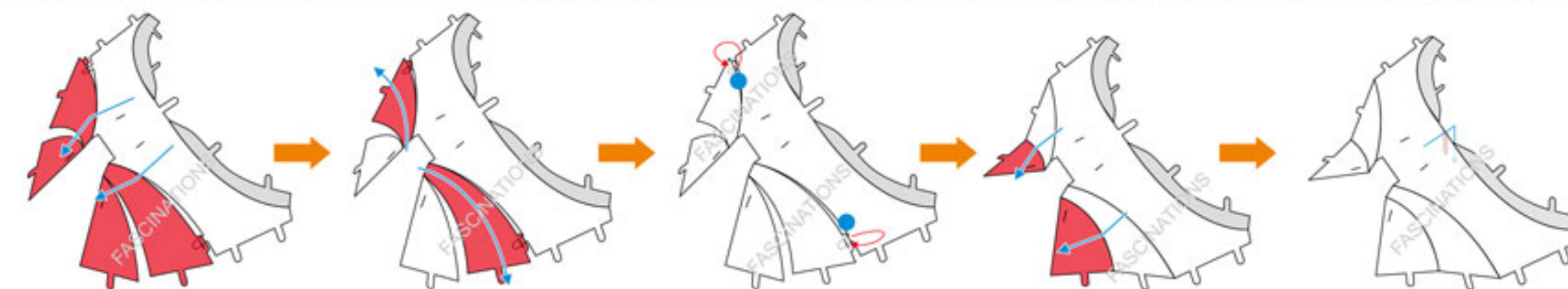
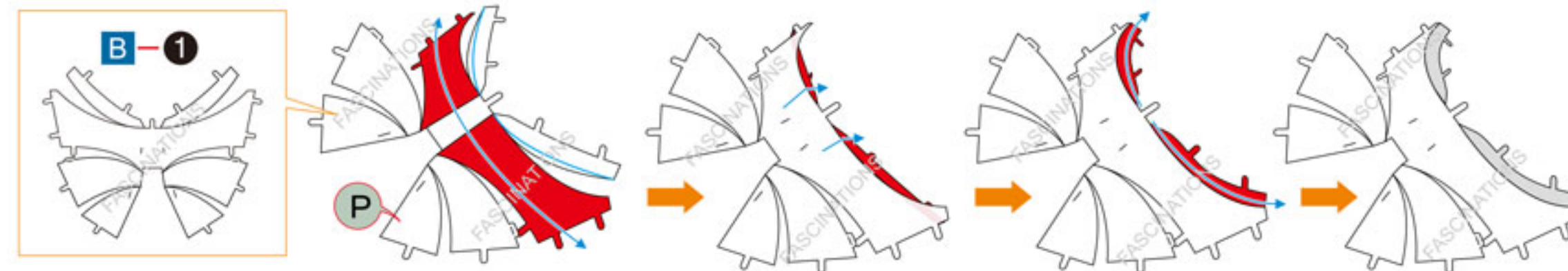

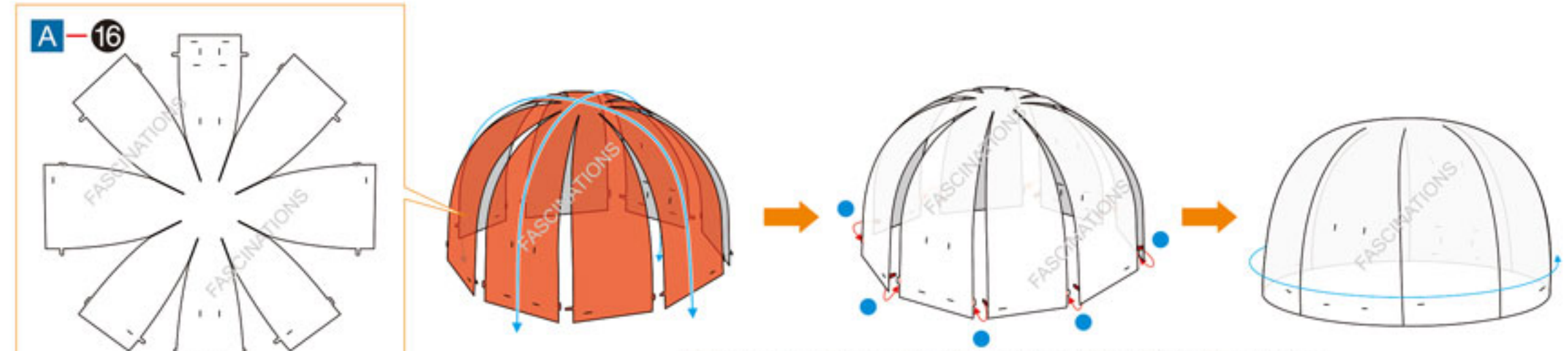
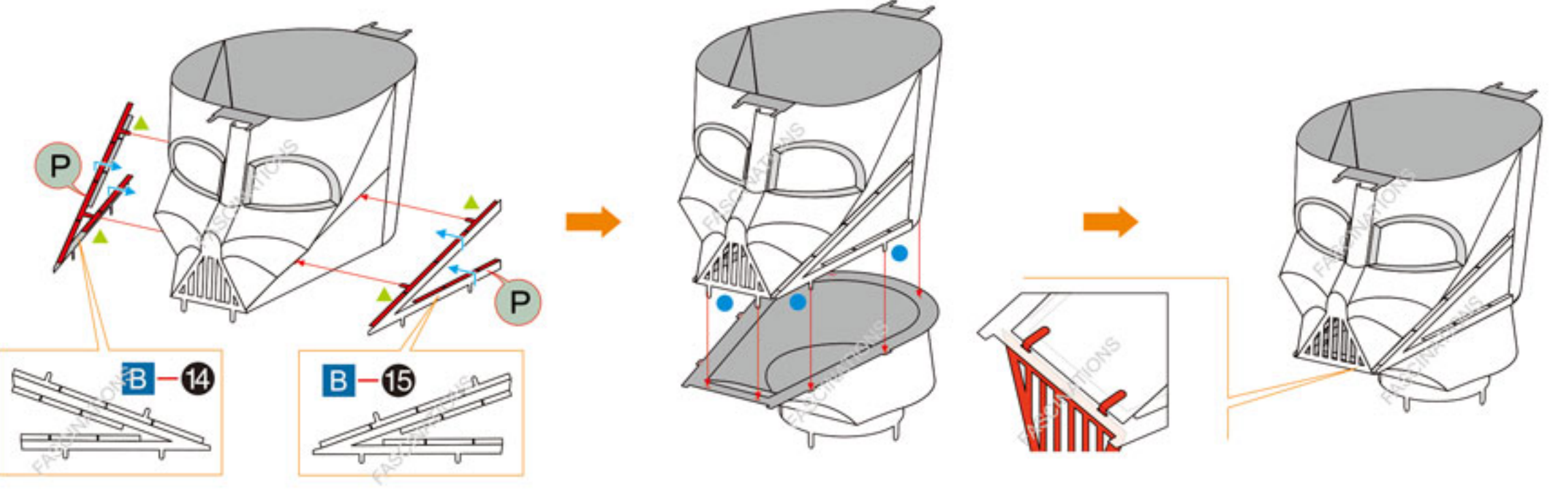
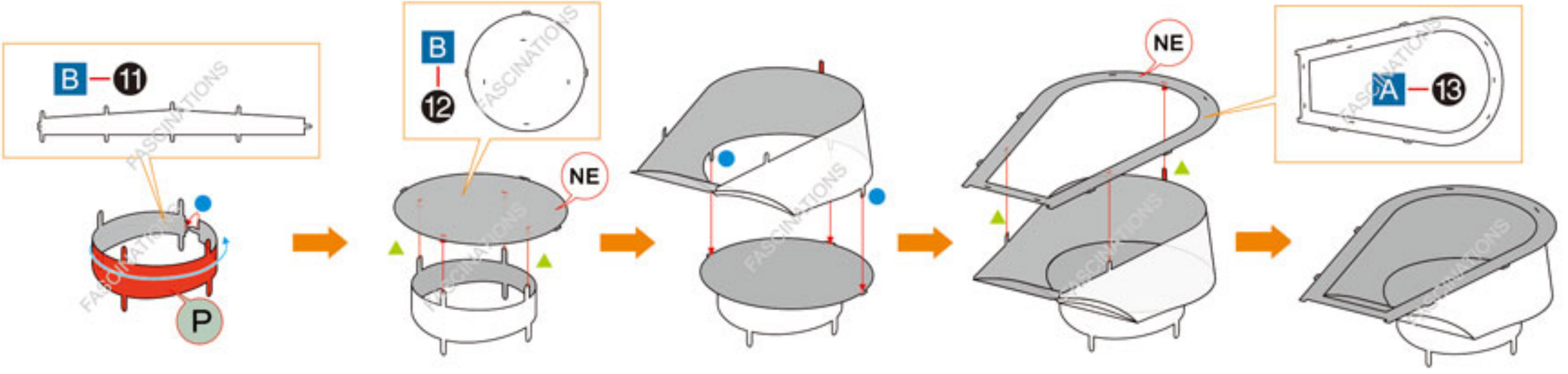
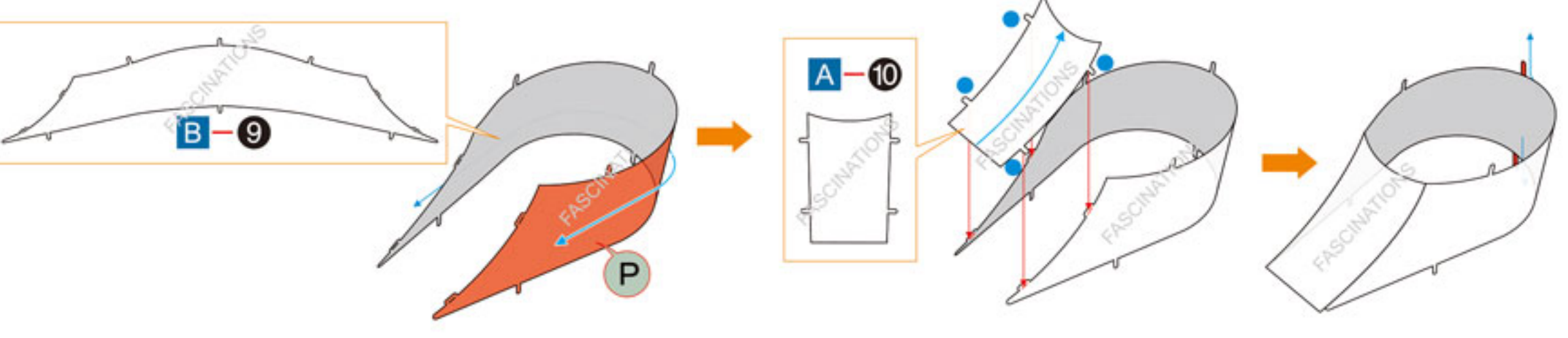
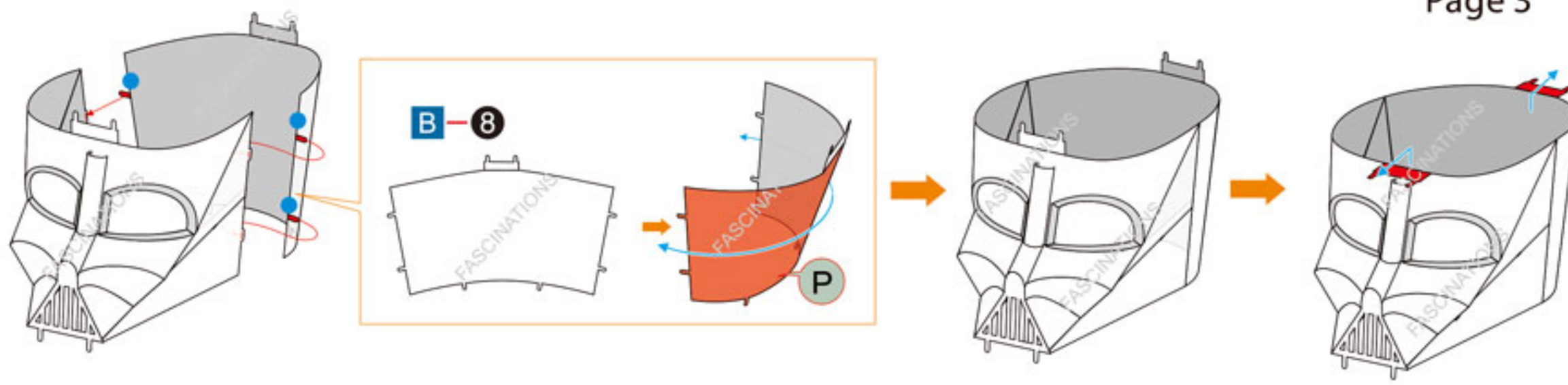

TIP: use a pair of pliers to bend the tabs down 90 degrees and the holes down 45 degrees before connecting them.

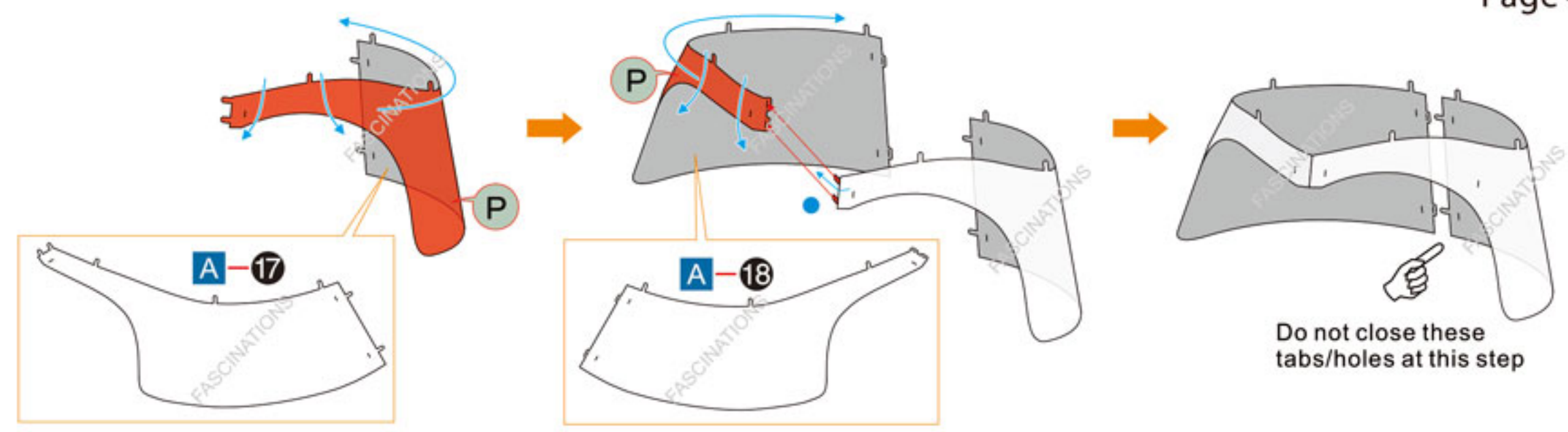

Do not close these tabs/holes at this step

